

20Z30A

30x optical zoom

1080p 30fps x30 Zoom Module

AHD 2.0 **CVBS**

1/3" CMOS	30fps Full HD 1080p	30fps REAL WDR	AF ZOOM
x30 ZOOM	3D DNR	DSS	MOTION



Features

- 1/3" 2MP Panasonic CMOS sensor
- 1080p 30fps, 720p 60fps/30fps
- x30 Optical Zoom(4.3mm~129mm) & x32 Digital Zoom
- Day & Night(ICR)
- Real-time True WDR
- Digital Noise Reduction(2D+3D)
- Digital Image Stabilizer
- Privacy Mask Function
- High Light Compensation
- Intelligent Motion Detection
- Defog Function
- Supports VISCA, Pelco-D/P Protocol
- Video Out : AHD 2.0, CVBS

Dimensions

Unit : mm

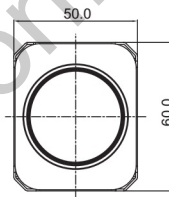

FRONT

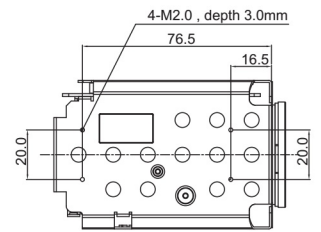

LEFT SIDE

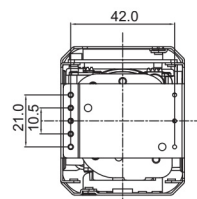

BACK

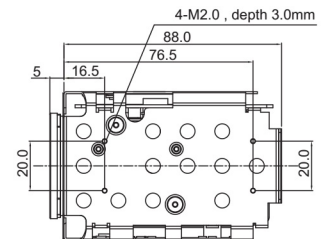

RIGHT SIDE

Field of View

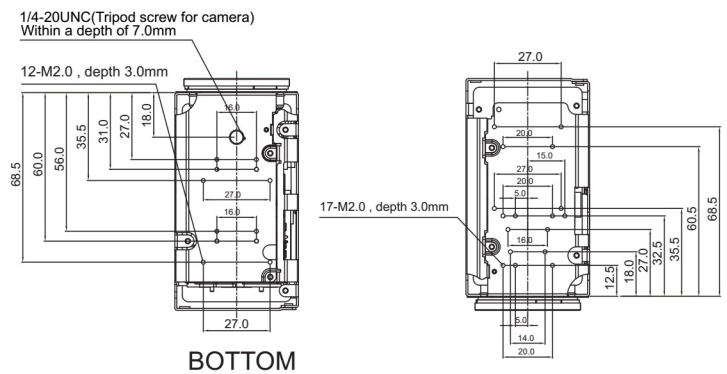
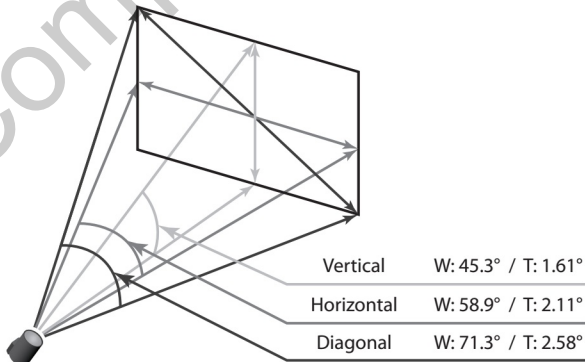

BOTTOM

TOP

Specifications

Image Sensor	1/3" Panasonic CMOS Sensor			
Total Pixels	1,956 (H) x 1,266 (V) = 2.48M Pixels			
Active Pixels	1,944 (H) x 1,092 (V) = 2.12M Pixels			
Scanning System	Progressive Scan			
Sync. System	Internal			
Resolution	Digital : 1080p/30(25)fps, 720p/60(50)fps, 720p/30(25)fps Analog : 700TVL			
Min. Illumination	Color(1/30s) : 0.5 lux , BW(1/30s) : 0.1lux Color DSS(1/7.5s) : 0.125 lux , BW DSS(1/7.5s) : 0.025 lux			
Video Output	HD : AHD Analog SD : VBS(without WDR)			
S/N Ratio	more than 50dB(AGC off)			
Lens Type	x30 Day & Night Zoom Lens			
Zoom Ratio	Optical x30, Digital x32 Zoom			
Focal Length	f = 4.3 mm ~ 129.0 mm			
Aperture Ratio	F1.6(wide) ~ F4.7(tele)			
Angle Of View(D, H, V)	Wide	71.3°	58.9°	45.3°
	Tele	2.58°	2.11°	1.61°
AF Mode	Auto / One Push / Manual			
Min. Distance	0.1 / 1.0 / 3.0 / 6.0 / 10.0 m			
Lens Refresh	One Push / 1 ~ 10Day			
Digital Zoom	Off / MAX x2 ~ x32			
Exposure	Auto / Iris.P / Shut.P / Manual			
Gain Control(AGC)	Off / On			
Shutter Speed	1/30(25) ~ 1/30,000 sec			
Iris	0 ~ 20 steps			
Digital Slow Shutter(DSS)	Off / x2 / x4 / (x8 : 60 or 50 fps mode only)			
Brightness	0 ~ 20 steps			
WDR/BLC	Off / WDR / BLC			
Day&Night	Auto / Day / Night / Ext-in			
White Balance	Auto / One Push / Manual / Indoor / Outdoor			
HLC	Off / On / Night Only			
DNR	Auto / Off / Low / Middle / High			
Mirror	Off / H / V / H&V			
Sharpness	0 ~ 10 steps			
ACE	Off / Low / Middle / High			
Defog	Off / On(Auto / Manual)			
Privacy Mask	Off / 24 positions			
Motion Detection	Off / 3 positions			
Defect Detection	Off / On			
System	NTSC / PAL			
Communication	Baud Rate : 2400 / 4800 / 9600 / 19200 / 38400 / 57600 / 115200 Protocol : VISCA / Pelco-D / Pelco- P / Update			
Power Source	9V to 15V DC			
Power Consumption	500mA			
Power Input	Connector			
Video Output	Connector			
Storage Temperature	-20°C ~ +60°C (Humidity : 0%RH ~ 90%RH)			
Operating Temperature	-10°C ~ +50°C (Humidity : 0%RH ~ 90%RH)			
Dimensions	50(W) x 60(H) x 93(D)			
Weight	240g			

Pin Assignment

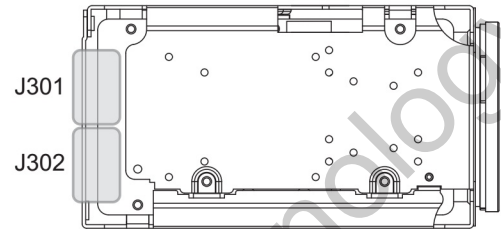

J301		J302	
1	GND	1	RxD
2	TxD	2	TxD
3	RxD	3	GND
4	NC	4	DC IN
5	GND	5	GND
6	AHD-OUT	6	VBS-OUT
7	GND	7	GND
8	ADKEY	8	AHD-OUT
9	NC	9	GND
10	D/N-IN	Ref 10019HR-09(YEONHO)	
11	NC		
12	MD-OUT	Ref 05002HR-24J05 (YEONHO)	
13	485-DIR		
14	F/W_SEL		
15	GND		
16	+5V		
17	GND		
18	VBS-OUT		
19	GND		
20	DC IN		