

FCB-EV Series

Color Block Camera

SONY



FCB-EV7100



FCB-EV5500



FCB-EV5300



FCB-EV7500



FCB-EV7300



FCB-EV7310

* This brochure is published based on the features and specifications for firmware Version 0310.

Exmor

Introduction

In response to growing demand for high-quality, high-resolution images, Sony is adding three new 20x optical zoom color models to its FCB-EV Series camera block line-up.

These cameras offer excellent picture quality, thanks to the use of Exmor™ CMOS image sensors and high-performance optical zoom lenses. Now Sony's FCB-EV Series covers a range of products from 10x to 30x, HD and Full-HD, and with or without analog video output, allowing you to select the right camera according to your specific and varying needs.

All of these cameras inherit a multitude of features from Sony's world-renowned FCB Series including Wide-D*¹, Auto ICR, and Spherical Privacy Zone Masking. These useful features are suitable for an array of applications and designed to satisfy all your needs.

*1 Wide dynamic range.

	FCB-EV7500	FCB-EV7300	FCB-EV7310	FCB-EV7100	FCB-EV5500	FCB-EV5300
Imager sensor	1/2.8-type CMOS			1/3-type CMOS		
Lens	30x	20x		10x	30x	20x
Picture quality	Full HD 1080p (1920 x 1080)			HD (1280 x 720)		
Minimum illumination*	Color: 0.35 lx (F1.6, AGC on, 1/30 s)	Color: 0.1 lx (F1.6, AGC on, 1/30 s)		Color: 0.35 lx (F1.8, AGC on, 1/30 s)	Color: 0.25 lx (F1.6, AGC on, 1/30 s)	Color: 0.05 lx (F1.6, AGC on, 1/30 s)
Digital zoom	12x (360x with optical zoom)	12x (240x with optical zoom)		12x (120x with optical zoom)	12x (360x with optical zoom)	12x (240x with optical zoom)
Video output (HD)	Digital/Analog		Digital	Digital/Analog		Digital
Video output (SD)	VBS					
Mass	260 g (9.2 oz)	270 g (9.6 oz)		210 g (7.4 oz)	260 g (9.2 oz)	270 g (9.6 oz)
Dimensions	50 x 60 x 89.7 mm (2 x 2 3/8 x 3 5/8 inches)	50 x 60 x 87.9 mm (2 x 2 3/8 x 3 1/2 inches)		45.6 x 48.8 x 78 mm (1 13/16 x 1 15/16 x 3 1/8 inches)	50 x 60 x 89.7 mm (2 x 2 3/8 x 3 5/8 inches)	50 x 60 x 87.9 mm (2 x 2 3/8 x 3 1/2 inches)
Defog	●	●	●	●	●	●
HLC (High Light Compensation)	●	●	●	●	●	●
Wide-D (Wide Dynamic range)	●	●		●	●	●
Image stabilizer	●	●			●	●
StableZoom	●	●	●	●	●	●
Auto ICR (Auto IR-cut Filter Removal)	●	●	●	●	●	●
Spherical privacy zone masking	●	●	●	●	●	●
Noise reduction	●	●	●	●	●	●
Slow AE response	●	●	●	●	●	●

* High sensitivity mode, ICR off.

Features

■ Capture crisp, clear Full-HD (1080/60p) images*²

The high-performance 1/2.8-type Exmor CMOS image sensor achieves superb Full-HD (1920 x 1080) picture quality, even in low-light environments. Progressive scanning assures smoother pictures with reduced blur – ideal for capturing the detail in moving images.

*²The FCB-EV5500 and FCB-EV5300 achieve crisp HD 720 picture quality.

■ Fast, bright lens with rapid 30x optical zoom*³

The FCB-EV7500 and FCB-EV5500 are equipped with a bright F1.6 maximum aperture and 30x optical zoom range. Fast zoom operation (from wide end to tele) is ideal for smooth, rapid transitions from wide area coverage to detailed close-ups in security and surveillance applications.

*³The FCB-EV7300 and FCB-7310 have 20x and the FCB-EV5300 has 10x optical zoom lenses.

■ Get a steadier picture with image stabilizer*⁴

The camera's built-in image stabilizer function counters the effect of blurred, shaky images caused by low-frequency vibration. This is useful for outdoor surveillance and traffic monitoring applications, particularly if the camera is used on a bridge or mounting pole where it is subjected to wind or mechanical vibration.

*⁴ Excludes the FCB-EV7310 and FCB-EV7100.

■ StableZoom

Image stabilizer and optical/digital zoom are combined to enhance picture quality while maintaining the original horizontal angle of view. This ensures no compromise in image size, and reduces blurring.

■ 2D/3D noise reduction

Advanced noise reduction technology filters noise from the image for clearer results, especially in low-light conditions. Noise reduction can be selected from five levels to suit a wide range of operating environments.

■ See more clearly with Visibility Enhancer

Picture quality is enhanced dynamically and adaptively on a pixel-by-pixel basis while continuously adapting to the scene within the given dynamic range.

■ Wide dynamic range

Wide-D image processing technology gives the ability to see clear, detailed images in high-contrast or backlit environments. All models now support an exceptionally wide 130 dB dynamic range, which is activated via VISCA command.*⁵

*⁵ For the FCB-EV7100/FCB-EV7500, the factory default setting is 90 dB. For the FCB-EV7300/FCB-EV5500/FCB-EV5300, it is 130 dB.

■ De-fog

The de-fog feature allows clearer and natural viewing in foggy or misty scenes. When this feature is activated, the camera detects the haze level and automatically applies the required effects. Depending on user requirements, the level of these effects can be adjusted via VISCA command.

■ HLC (High Light Compensation)

HLC technology helps to improve, for example, the visibility of license plates when bright headlights are shot under low-light conditions. The bright parts in the image are masked and compensated for automatically to achieve better visibility.

■ Clear vision around the clock with Day/Night

Benefit from optimized picture quality in changing light conditions – a frequent challenge in around-the-clock security operations. In high sensitivity mode the FCB-EV5300 can operate effectively in lighting levels as low as 0.05 lx (ICR off).

■ Auto ICR (Auto IR-cut Filter Removal)

In low-light conditions, the camera automatically switches from Day to Night mode, removing the IR-cut filter to boost sensitivity for clear pictures in near-darkness. The spherical privacy zone masking feature enables areas of view to be selectively masked for privacy. Masked areas are automatically interlocked with the camera's pan/tilt/zoom movements.

■ Choice of HD and SD output modes

Video signal outputs are available in a range of HD (digital and analog) and SD formats, reducing integration cost and complexity by avoiding the need for additional analog/ digital converters. Video output modes can be changed 'on the fly' during normal operation, without a hardware reboot of the camera.

■ One-cable connection for simpler integration

A single cable carries HD video signals plus VISCA communication and the power supply. Integration flexibility is further supported by both 30-pin micro coaxial (digital output) and 24-pin FFC (analog output) interfaces.

■ Wide range of features for versatile operation

Versatile operation is ensured by a wide range of functions and adjustments, including: White Balance modes; Picture effects (E-Flip, Nega Art, Black & White, Mirror Image, Color Enhancement); Motion Detection/ Alarm; Picture freeze; Temperature readout; Slow AE response; Electronic shutter/ slow shutter; and Title display/Camera mode display (English).

SPECIFICATIONS

	FCB-EV7500	FCB-EV7300	FCB-EV7310	FCB-EV7100	FCB-EV5500	FCB-EV5300
Image sensor	1/2.8-type Exmor CMOS				1/3.0-type Exmor CMOS	
Image sensor (Number of effective pixels)	Approx. 2.38 Megapixels				Approx. 1.37 Megapixels	
Signal system	1080p/59.94, 1080p/50, 1080p/60, 1080p/30, 1080p/29.97, 1080p/25, 1080i/59.94, 1080i/50, 1080i/60, 1080i/30, 720p/59.94, 720p/50, 720p/60, 720p/30, 720p/29.97, 720p/25, NTSC*, PAL*				720p/60, 720p/30, 720p/59.94, 720p/50, 720p/29.97, 720p/25, NTSC*, PAL*	
Minimum illumination (50%)	High sensitivity mode	Color: 0.35 lx (F1.6, AGC on, 1/30 s)	Color: 0.1 lx (F1.6, AGC on, 1/30 s)	Color: 0.35 lx (F1.8, AGC on, 1/30 s)	Color: 0.25 lx (F1.6, AGC on, 1/30 s)	Color: 0.05 lx (F1.6, AGC on, 1/30 s)
	Normal mode	Color: 1.4 lx (F1.6, AGC on, 1/30 s)	Color: 0.4 lx (F1.6, AGC on, 1/30 s)	Color: 1.4 lx (F1.8, AGC on, 1/30 s)	Color: 1.0 lx (F1.6, AGC on, 1/30 s)	Color: 0.2 lx (F1.6, AGC on, 1/30 s)
S/N ratio	More than 50 dB					
Gain	Auto/Manual (0 step to 28 step, +2 step/total 15 steps)	Auto/Manual (0 step to 28 step (0 dB to 48.8 dB), +2 step/total 15 steps)	Auto/Manual (0 step to 28 step (0 dB to 47.8 dB), +2 step/total 15 steps)	Auto/Manual (0 step to 28 step, +2 step/total 15 steps)	Auto/Manual (0 step to 28 step (0 dB to 51.9 dB), +2 step/total 15 steps)	
	Max. Gain Limit (6 step to 28 step, +2 step step/total 12 steps)	Max. Gain Limit (6 step to 28 step (17.4 dB to 48.8 dB), +2 step step/total 12 steps)	Max. Gain Limit (6 step to 28 step (17.1 dB to 47.8 dB), +2 step step/total 12 steps)	Max. Gain Limit (6 step to 28 step, +2 step/total 12 steps)	Max. Gain Limit (6 step to 28 step (18.5 dB to 51.9 dB), +2 step step/total 12 steps)	
Shutter speed	1/1 s to 1/10,000 s, 22 steps					
Sync system	Internal					
Exposure control	Auto, Manual, Priority mode (shutter priority & iris priority), Bright, EV compensation, Slow AE					
Backlight compensation	Yes					
Aperture control	16 steps					
White balance	Auto, ATW, Indoor, Outdoor, Outdoor Auto, Sodium Vapor Lamp (Fix/Auto/Outdoor Auto), One-push, Manual					
Lens	30x optical zoom f = 4.3 mm (wide) to 129.0 mm (tele) F1.6 to F4.7	20x optical zoom f = 4.7 mm (wide) to 94.0 mm (tele) F1.6 to F3.5		10x optical zoom f = 3.8 mm (wide) to 38 mm (tele) F1.8 to F3.4	30x optical zoom f = 4.3 mm (wide) to 129.0 mm (tele) F1.6 to F4.7	20x optical zoom f = 4.7 mm (wide) to 94.0 mm (tele) F1.6 to F3.5
	Digital zoom	12x (360x with optical zoom)	12x (240x with optical zoom)	12x (120x with optical zoom)	12x (360x with optical zoom)	12x (240x with optical zoom)
Focusing system	Auto (Sensitivity: normal, low), One-push AF, Manual, Interval AF, Zoom Trigger AF, Focus compensation in ICR on					
Horizontal viewing angle	1080p mode	63.7° (wide end) to 2.3° (tele end)	59.5° (wide end) to 3.3° (tele end)	67.0° (wide end) to 7.6° (tele end)	-	
	720p mode	63.7° (wide end) to 2.3° (tele end)	59.5° (wide end) to 3.3° (tele end)	67.0° (wide end) to 7.6° (tele end)	58.3° (wide end) to 2.1° (tele end)	54.1° (wide end) to 2.9° (tele end)
	SD	47.8° (wide end) to 1.7° (tele end)	44.6° (wide end) to 2.5° (tele end)	50.3° (wide end) to 5.7° (tele end)	58.3° (wide end) to 2.1° (tele end)	54.1° (wide end) to 2.9° (tele end)
Minimum object distance	10 mm (wide end) to 1200 mm (tele end) (Default: 300 mm)	10 mm (wide end) to 1,000 mm (tele end) (Default: 300 mm)		10 mm (wide end) to 800 mm (tele end) (Default: 320 mm)	10 mm (wide end) to 1200 mm (tele end) (Default: 300 mm)	10 mm (wide end) to 1,000 mm (tele end) (Default: 300 mm)
Auto ICR	Yes					
Wide-D*	Yes (130 dB)		No	Yes (130 dB)		
Visibility Enhancer	Yes					
De-fog	Yes					
HLC	Yes					
Noise reduction	Yes (6 steps)					
Progressive scan mode	Yes					
Image stabilization	Yes		No	Yes		
Image stabilization for still image	Yes		No	Yes		
StableZoom	Yes					
Digital output	Yes					
Spherical privacy zone masking	Yes					
Motion detection	Yes					
Alarm	No					
Slow AE response	Yes					
Picture effects	E-Flip, Nega Art, Black & White, Mirror image, Color enhancement					
Picture freeze	Yes					
Slow shutter	Yes					
Temperature readout	Yes					
Title display	20 characters/line, max. 11 lines					
Camera mode display	Yes					
Key switch control	No					
Camera operation switch	No					
Video output	HD	Analog: Component (Y/Pa/Ps)		N/A	Analog: Component (Y/Pa/Ps)	
	SD	Digital: Y/Cb/Cr 4:2:2 via LVDS (Signal format conforms to SMPTE 274/SMPTE 296.)			Digital: Y/Cb/Cr 4:2:2 via LVDS (Signal format conforms to SMPTE 296.)	
Camera control interface	VISCA (CMOS 5 V level)			VISCA protocol (CMOS 5V level)	VISCA (CMOS 5 V level)	
	Baud rate: 9.6 Kbps, 19.2 Kbps, 38.4 Kbps, 115.2 Kbps, Stop bit: 1 bit					
Power requirements	6.0 V to 12.0 V DC					
Power consumption	2.9 W (zoom/focus inactive)	3.0 W (zoom/focus inactive)	2.4 W (zoom/focus inactive)	3.4 W (zoom/focus inactive)	2.9 W (zoom/focus inactive)	1.9 W (zoom/focus inactive)
	3.7 W (zoom/focus active)	3.5 W (zoom/focus active)	2.9 W (zoom/focus active)	3.7 W (zoom/focus active)	3.5 W (zoom/focus active)	2.4 W (zoom/focus active)
Operating temperature	-5°C to +60°C (23°F to 140°F)					
Storage temperature	-20°C to +60°C (-4°F to 140 °F)					
Operating humidity	20% to 80%, Absolute humidity: 36 g/m ³					
Storage humidity	20% to 95%, Absolute humidity: 36 g/m ³					
Dimensions (W x H x D)	50.0 x 60.0 x 89.7 mm (2 x 2 3/8 x 3 5/8 inches)	50.0 x 60.0 x 87.9 mm (2 x 2 3/8 x 3 1/2 inches)		45.6 x 48.8 x 78.0 mm (1 13/16 x 1 15/16 x 3 1/8 inches)	50.0 x 60.0 x 89.7 mm (2 x 2 3/8 x 3 5/8 inches)	50.0 x 60.0 x 87.9 mm (2 x 2 3/8 x 3 1/2 inches)
	Mass	260 g (9.2 oz)		270 g (9.6 oz)	210 g (7.4 oz)	260 g (9.2 oz)

*1 Non-standard video format *2 Wide dynamic range

Dimensions

Unit: mm (inches)

FCB-EV7500 / FCB-EV5500

Front

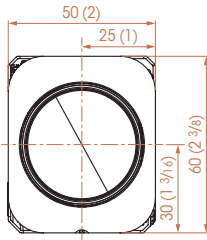

Top

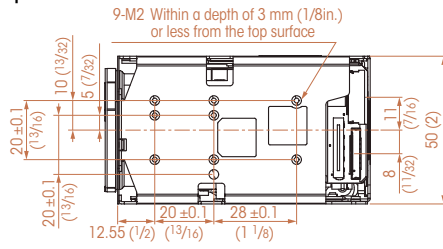

Bottom

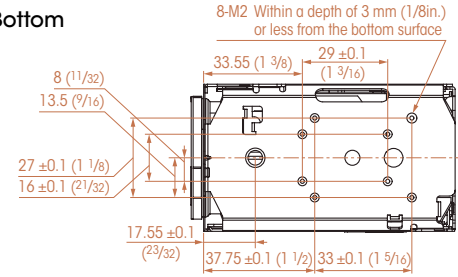

Rear

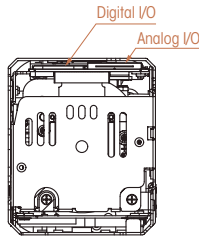

Left

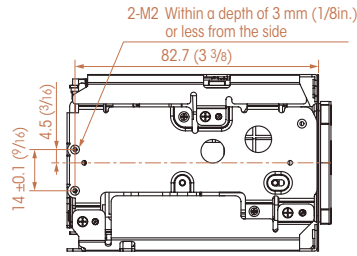

Right

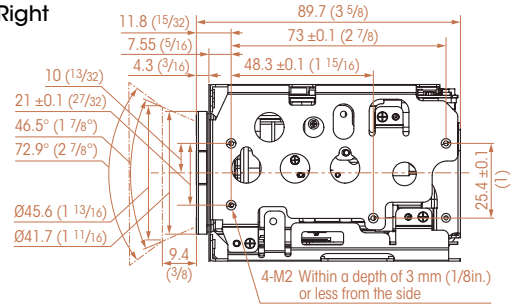

FCB-EV7300 / FCB-EV7310 / FCB-EV5300

Front

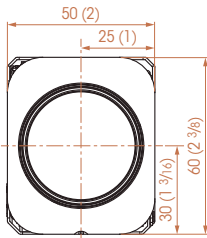

Top

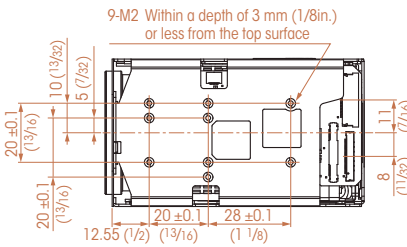

Bottom

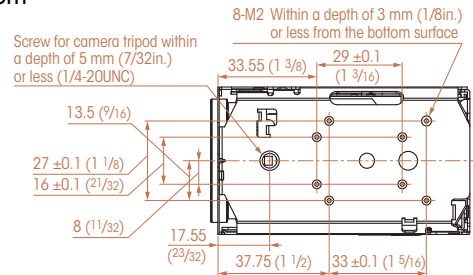

Rear

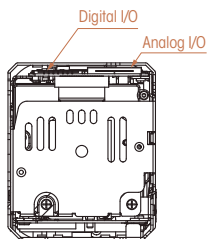

Left

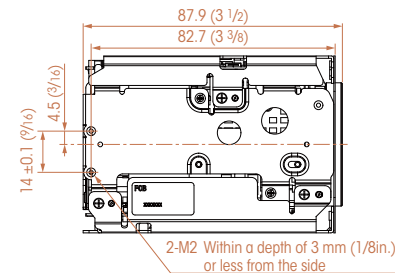

Right

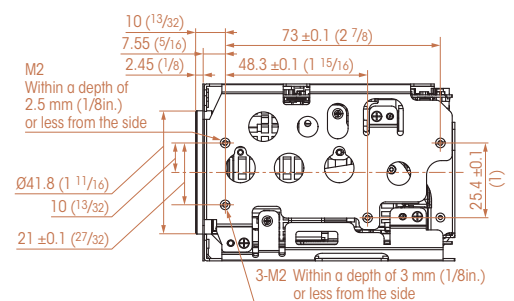

FCB-EV7100

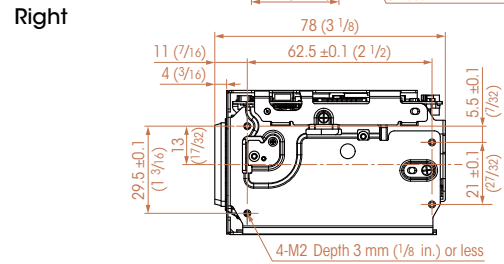
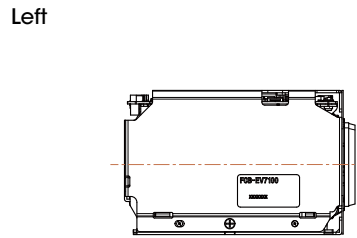
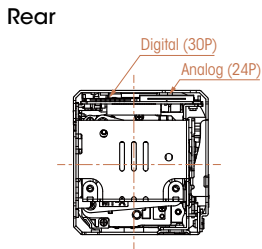
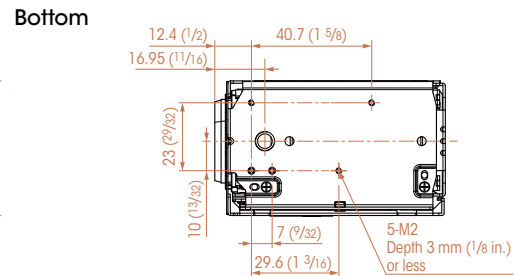
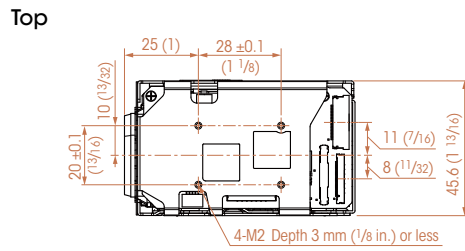
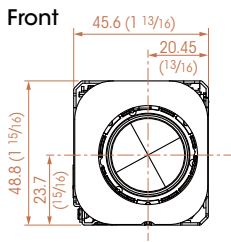

PIN ASSIGNMENTS

CN401

Pin No.	Name	Level
1	TXOUT3+	
2	TXOUT3-	
3	TXCLKOUT+	
4	TXCLKOUT-	
5	TXOUT2+	
6	TXOUT2-	
7	TXOUT1+	
8	TXOUT1-	
9	TXOUT0+	
10	TXOUT0-	
11	GND	
12	TxD	CMOS 5 V (Low: Max. 0.1 V, High: Min. 4.4 V)
13	RxD	CMOS 5 V (Low: Max. 1.0 V, High: Min. 2.3 V)
14	DC IN	6 to 12 V DC
15	DC IN	6 to 12 V DC

Connector: USL00-30L-C (KEL Co.)

Pin No.	Name	Level
16	DC IN	6 to 12 V DC
17	DC IN	6 to 12 V DC
18	DC IN	6 to 12 V DC
19	GND	
20	GND	
21	TXOUT7+	Single out mode: open
22	TXOUT7-	Single out mode: open
23	TXOUT6+	Single out mode: open
24	TXOUT6-	Single out mode: open
25	NC	
26	RESET	Reset: Low (GND) Normal: Open (1.8 V)
27	TXOUT5+	Single out mode: open
28	TXOUT5-	Single out mode: open
29	TXOUT4+	Single out mode: open
30	TXOUT4-	Single out mode: open

CN501

Pin No.	Name	Level
1	GND	
2	TxD	CMOS 5 V (Low: Max. 0.1 V, High: Min. 4.4 V)
3	RxD	CMOS 5 V (Low: Max. 1.0 V, High: Min. 2.3 V)
4	RESET	Reset: Low (GND) Normal: Open (1.8 V)
5	GND	
6	NC	
7	GND	
8	NC	
9	GND	
10	VBS-OUT	
11	GND	
12	Y-OUT	HD Analog Component
13	GND	
14	Pb-OUT	HD Analog Component

Connector: 046240024006800+ (Kyocera-elco)

Pin No.	Name	Level
15	GND	
16	Pr-OUT	HD Analog Component
17	GND	
18	DC IN	6 to 12 V DC
19	DC IN	6 to 12 V DC
20	DC IN	6 to 12 V DC
21	DC IN	6 to 12 V DC
22	GND	
23	DC IN	6 to 12 V DC
24	GND	

Distributed by

©2014 Sony Corporation. All rights reserved.
 Reproduction in whole or in part without written permission is prohibited.
 Features and specifications are subject to change without notice.
 The values for mass and dimensions are approximate.
 "SONY" and "Exmor" are registered trademarks of Sony Corporation.
 All other trademarks are the property of their respective owners.