

# TAMRON

Lenses for Machine Vision/Factory Automation

## High Resolution



- Super High Resolution 25mm 3-Megapixel Lens
  - 1.3-Megapixel Lens Series
  - Standard High Resolution Lens Series

# MEGAPIXEL

## High Resolution Lenses Designed Specifically for Megapixel Cameras (More Than 1.3-Million Pixels)

### Low Distortion

Tamron's new lenses offer ultra low distortion for use on high-resolution cameras using 1.3 million pixels or more. In fact, the 25mm and 50mm boast 0% distortion, thus providing excellent optical performance from corner to corner.

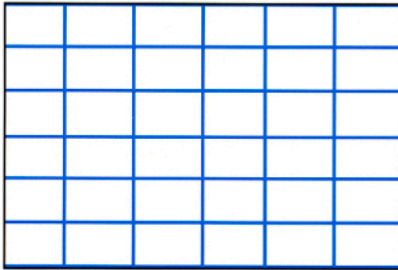

Models 23FM25SP and 23FM50SP feature 0% distortion

### Close Minimum Object Distance

The Megapixel lenses feature a high close-up capability, yet there is no sacrifice in optical resolution, brightness or contrast, providing excellent details of complex items even at these close distances. With an MOD of just 0.15m on the 16mm and 25mm and only 0.20m on the 50mm without the use of extension rings, these lenses are well suited for machine vision applications where close inspection of smaller objects is needed.

### Compact Design

Like all of Tamron's machine vision lenses, the Megapixel Series offers a compact design that makes fitting these lenses to various inspection apparatus and automation equipment easy. The maximum diameter on each lens is a mere Ø34mm and they accept a Ø30.5mm filter. The lenses also feature mechanism screws for both focus and iris adjustments, especially important when the lenses are used on vibrating inspection equipment.

### High Resolution

Megapixel Cameras are becoming increasingly popular in markets where high image quality is absolutely necessary. Tamron's new lenses offer remarkable resolution to meet these needs

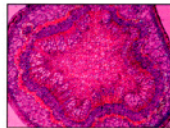
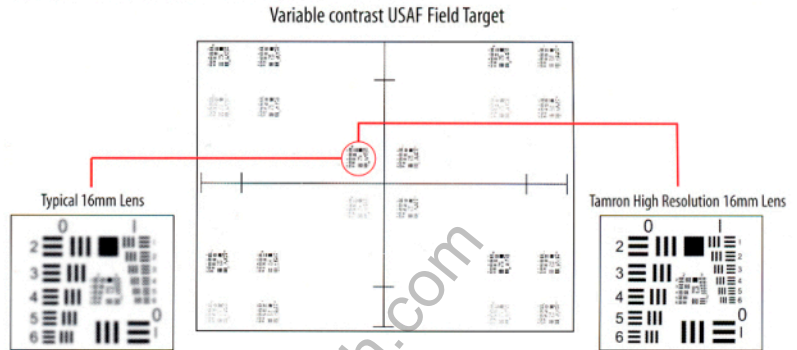

Pharmaceutical

The testing and analysis of various compounds are differentiated easily by quality images produced by a machine vision system.

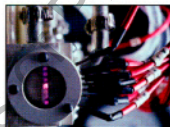

General Manufacturing

Lenses are utilized in various quality control measures to assure uniformity and precise manufacturing techniques.

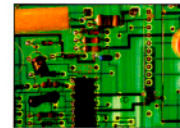

Semiconductor

Printed Circuit board layout and design can be seen with superb detail utilizing high resolution megapixel lenses.

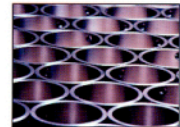

Factory Automation

High speed analysis of products in manufacturing facilities are viewed for inventory tags and manufacturing codes.

### Expanded Versatility with Extension Tubes

#### Shooting Distance and Coverage when the Lenses are Used with Extension Tubes

unit=mm

Size of Extension Ring	23FM16SP		23FM25SP		23FM50SP	
	Distance	Coverage	Distance	Coverage	Distance	Coverage
w/o Ext. Ring	142.2	87.1x65.0	148.3	57.1x42.7	191.8	30.2x22.7
0.5mm	494.6	283.6x212.2	1231.6	440.6x330.3	5012.4	878.9x659.2
	105.4	67.0x50.0	129.9	50.8x38.0	186.1	29.2x21.9
1mm	239.0	142.1x106.2	606.8	220.4x165.2	2517.5	439.6x329.7
	82.4	54.5x40.7	115.1	45.7x34.2	180.8	28.3x21.2
1.5mm	153.7	94.8x70.9	398.6	147.0x110.1	1685.5	293.1x219.8
	66.7	45.9x34.3	103.0	41.6x31.1	175.8	27.4x20.5
5mm	34.3	28.7x21.4	107.2	44.3x33.1	520.2	88.0x66.0
	22.8	22.0x16.3	55.9	25.5x19.0	148.0	22.5x16.9
10mm	8.7	14.5x10.7	44.7	22.3x16.6	270.5	44.0x33.0
	5.8	12.7x9.4	29.6	16.4x12.3	122.0	17.9x13.4
15mm	0.2	9.8x7.2	23.9	14.9x11.1	187.2	29.3x22.0
			17.1	12.2x9.1	104.8	14.9x11.1
20mm			13.5	11.2x8.4	145.6	22.0x16.5
			9.8	9.7x7.2	92.6	12.7x9.5
25mm			7.2	9.0x6.7	120.6	17.6x13.2
			5.0	8.0x6.0	83.5	11.1x8.3
30mm			3.1	7.6x5.6	103.9	14.7x11.0
			1.7	6.9x5.1	76.5	9.8x7.4
35mm			0.1	6.5x4.8	92.0	12.6x9.4
					70.8	8.9x6.6
40mm					83.1	11.0x8.2
					66.2	8.0x6.0

Upper column: Data at infinity focusing position.  
Lower column: Data at the nearest focusing position.

Taking distance: From physical front end of lens to the object.

The data for the coverage is for 2/3" cameras.

When the lenses are fitted with 1/2" cameras or 1/3" cameras, the coverage can be calculated with the following formula:

- 1) Coverage in 1/2" Cameras-data x 0.73
- 2) Coverage in 1/3" Cameras-data x 0.55

## 2/3 16mm F/1.4 Model 23FM16SP

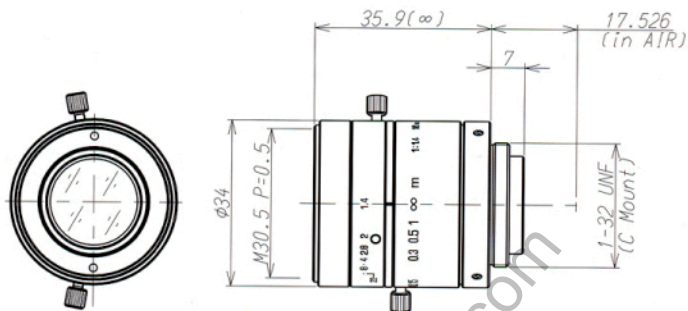

## 2/3 25mm F/1.4 Model 23FM25SP

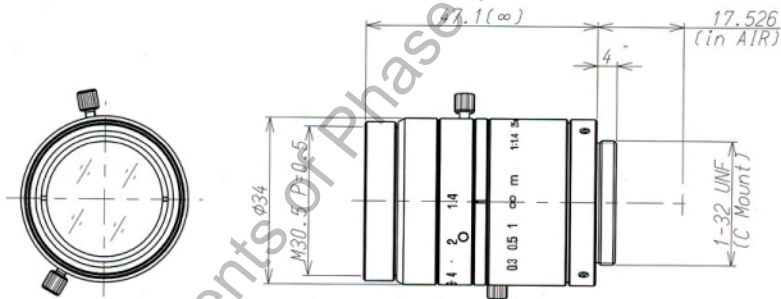

## 2/3 50mm F/2.8 Model 23FM50SP

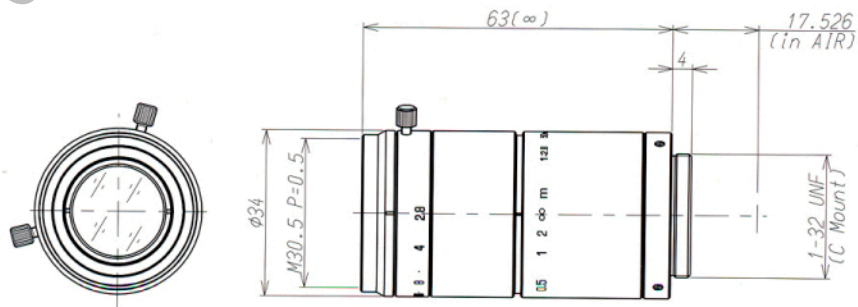

# STANDARD HIGH RESOLUTION

High Resolution Lenses Designed Specifically for Factory Automation/Machine Vision

## Maximum Performance

### HIGH RESOLUTION:

Every optical aberration is thoroughly compensated for and as a result, high resolution is achieved from corner to corner.

Furthermore, our standard high resolution lenses are optically designed to achieve high quality performance even at minimum focusing distances.

### DISTORTION COMPENSATION:

High resolution is achieved by thoroughly compensating for aberrations and distortion, a critical requirement of image processing.

## Maximum Reliability

### SOLID MECHANISM:

In order to endure the vibration of factory automation apparatus, solid mechanisms are utilized. This makes it possible to maintain the finest quality even after long periods of use.

### LOCK MECHANISM:

Special versions of the lenses are available featuring lock mechanisms for the iris and focus making their use ideal in places suffering significant vibrations.

## Maximum Flexibility

### CLOSER MOD:

The lenses feature an advanced mechanical construction that achieves a closer Minimum Object Distance (MOD). The MOD of the 50mm and 75mm is just 0.5m and less than 0.3m for all the other lenses. Due to the greater focusing range, the lenses offer more coverage when they are used with the optional extension rings.

### COMPACT DESIGN:

Tamron's compact lenses fit in the dimensional requirements of the machinery. The lenses that cover the most popular angles of view (8mm, 12mm, 16mm, 35mm, 25mm, 50mm, 75mm) each feature the same barrel diameter.

### UNIFORM FILTER SIZE:

All the lenses (excluding the 23FM65) have a uniform filter size of M25.5 PO.5. Available filters include a UV, Polarizer, Red, Green and Blue.

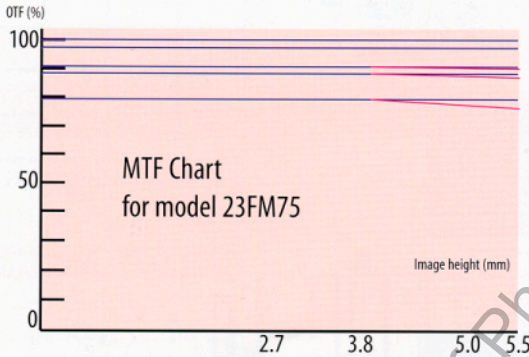

## 2/3 6.5mm F/1.4 Model 23FM65

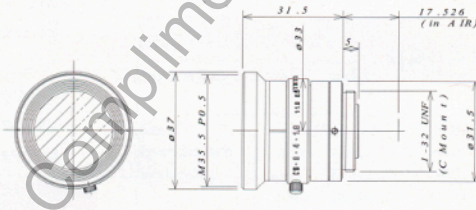

## 2/3 8mm F/1.4 Model 23FM08/23FM08L

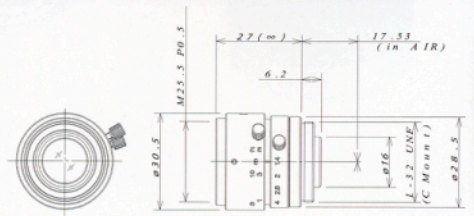
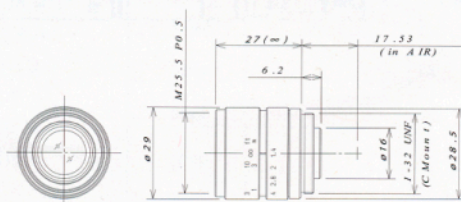

23FM08L

# STANDARD HIGH RESOLUTION

High Resolution Lenses Designed Specifically for Factory Automation/Machine Vision

## 2/3 12mm F/1.8 Model 23FM12/23FM12L

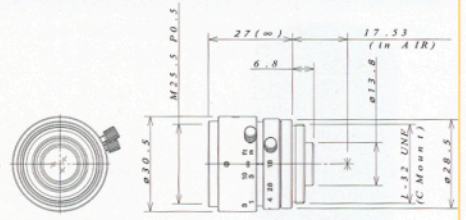
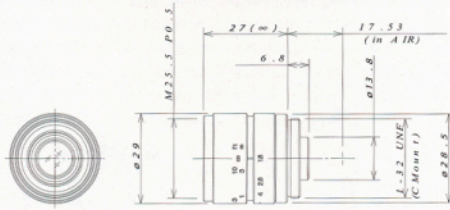

## 2/3 16mm F/1.4 Model 23FM16/23FM16L

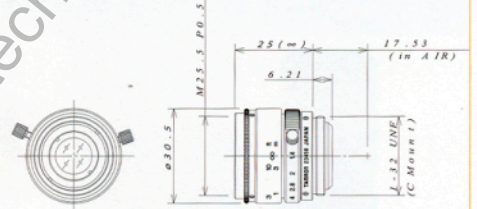
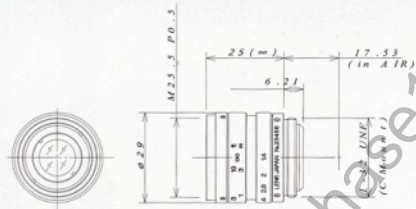

## 2/3 25mm F/1.6 Model 23FM25/23FM25L

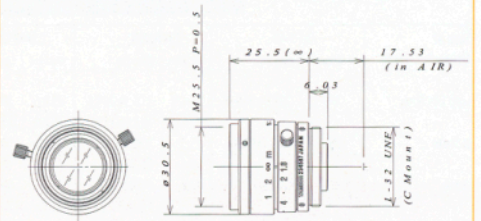
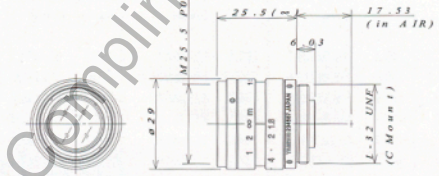

## 2/3 35mm F/2.1 Model 23FM35L

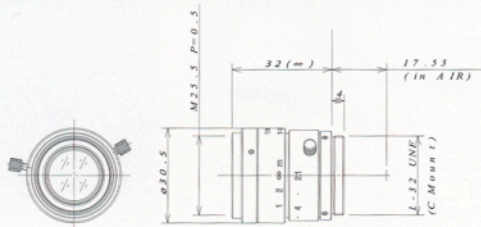

# STANDARD HIGH RESOLUTION

High Resolution Lenses Designed Specifically for Factory Automation/Machine Vision

## 2/3" 50mm F/2.8 Model 23FM50/23FM50L

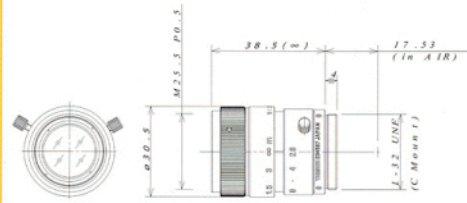
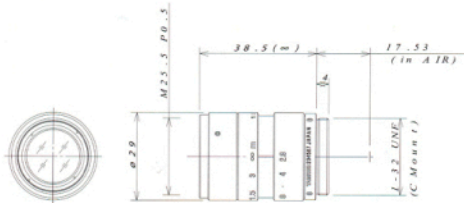

## 2/3" 75mm F/3.9 Model 23FM75/23FM75L

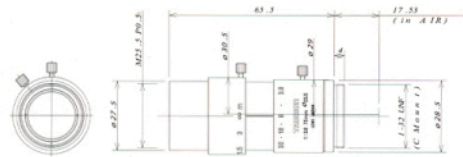

### Expanded Versatility with Extension Tubes

#### Shooting Distance and Coverage when the Standard High Resolution Lenses are Used with Extension Tubes

unit=mm

Size of Extension Ring	23FM65		23FM08L		23FM12L		23FM16L		23FM25L		23FM35L		23FM50L		23FM75L	
	Distance	Coverage	Distance	Coverage	Distance	Coverage	Distance	Coverage	Distance	Coverage	Distance	Coverage	Distance	Coverage	Distance	Coverage
w/o Ext.Ring	149.7	233.2x169.9	254.9	310.7x169.6	253.6	209.4x155.1	290.3	166.0x123.1	205.5	72.7x54.4	292.5	68.4x51.3	442.4	68.8x51.6	497.0	51.4x38.6
0.5mm	75.8	126.7x91.9	124.0	153.0x112.1	120.3	104.1x77.2	181.9	106.3x78.7	176.4	62.5x46.8	265.2	61.5x46.2	413.9	63.8x47.9	480.6	49.5x37.1
1mm	32.2	636.x46	56.6	76.3x55.8	135.7	109.1x81.0	255.5	146.9x108.9	625.1	220.3x165.2	1241.7	306.9x230.6	2547.6	438.2x329.2	5418.0	642.6x482.3
1.5mm			34.2	50.8x37.2	86.8	72.7x54.0	167.1	98.1x72.7	416.6	147.0x110.1	833.0	204.7x153.8	1715.7	292.4x219.5	3634.8	428.4x321.5
5mm			25.8	42.7x31.3	54.1	51.8x38.4	101.5	61.9x45.8	137.5	48.7x36.5	224.3	51.3x38.5	367.9	55.7x41.8	451.2	45.9x34.5
			2.8	15.0x11.1	18.4	21.7x16.1	43.4	29.7x21.9	124.7	44.3x33.1	260.8	61.5x46.2	550.5	87.8x65.9	1138.9	128.6x96.5
			1.3	14.0x10.3	12.1	18.7x13.9	35.4	25.2x18.6	77.5	27.5x20.6	149.0	32.4x24.3	270.4	38.6x29.0	374.8	36.8x27.6
10mm					3.7	10.8x8.0			62.2	22.1x16.6	138.2	30.8x23.1	300.7	43.9x33.0	604.1	64.3x48.2
					0.7	9.7x7.3			47.6	17.0x12.7	104.5	21.2x15.9	203.4	26.8x20.1	306.9	28.6x21.4
15mm									41.4	14.8x11.0	97.3	20.5x15.4	217.4	29.3x22.0	425.8	42.9x32.2
20mm									34.3	12.3x9.2	82.8	15.8x11.9	167.7	20.6x15.4	263.7	23.4x17.5
									30.9	11.1x8.3	76.9	15.4x11.6	175.8	22.0x16.5	336.7	32.2x24.1
									26.8	9.6x7.2	70.0	12.6x9.4	145.6	16.7x12.5	233.8	19.8x14.8
25mm											64.6	12.3x9.2	150.8	17.6x13.2	283.2	25.7x19.3
											61.5	10.4x7.8	130.5	14.0x10.5	211.9	17.2x12.9
30mm											56.5	10.3x7.7	134.2	14.7x11.0	247.6	21.4x16.1
											55.5	8.9x6.7	119.6	12.1x9.1	195.1	15.1x11.4
35mm											50.6	8.8x6.6	122.3	12.6x9.4	222.1	18.4x13.8
											51.0	7.8x5.9	111.3	10.6x8.0	181.9	13.5x10.2
40mm											46.3	7.7x5.8	113.4	11.0x8.2	203.0	16.1x12.1
											47.5	6.9x5.2	104.8	9.5x7.1	171.2	12.3x9.2

Upper column: Data at infinity focusing position.

Lower column: Data at the nearest focusing position.

Taking distance: From physical front end of lens to the object.

The data for the coverage is for 2/3" cameras.

When the lenses are fitted with 1/2" cameras or 1/3" cameras, the coverage can be calculated with the following formula:

1) Coverage in 1/2" Cameras- data x 0.73

2) Coverage in 1/3" Cameras- data x 0.55

# SUPER HIGH RESOLUTION

Ultra High Resolution Lens for Use with  
3-Million plus Pixel Cameras

## Super High Resolution

The high resolution achieved by this lens is a direct result of the thorough compensation of aberrations that are successfully lowered by Tamron through the use of advanced optical designs. High resolution of 200 lines at the center and 160 lines at the corners is achieved.

## Low Distortion

This same technology provides tremendous distortion compensation that ensures high resolution from corner to corner even at the closer minimum focusing distance (M.O.D.) of 0.6m. Less than -0.2% TV distortion at all apertures is the remarkable result.

## Maximum Corner Brightness

This lens provides less corner illumination loss and therefore maximum brightness, even at 4.8mm image height (70% brightness).

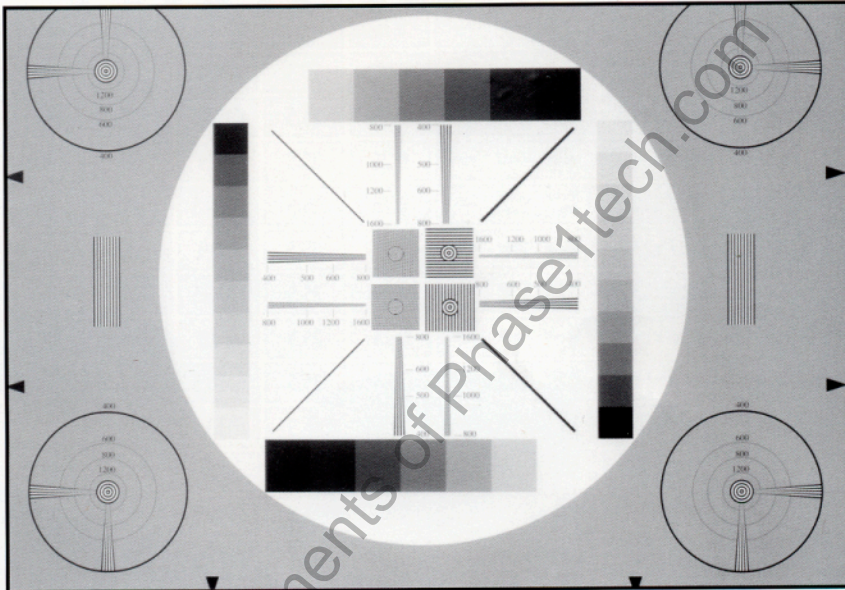

Test target with Tamron 25mm F/1.4 Super High Resolution Lens.

## 25mm F/1.4 Model 26HA

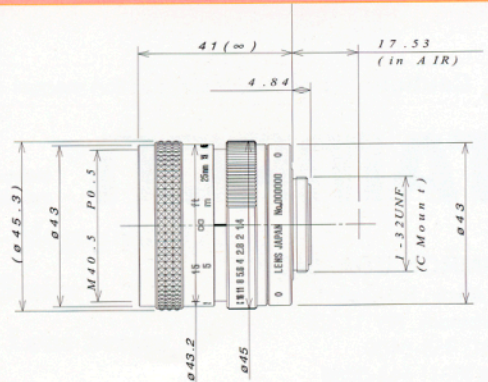
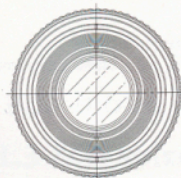

# SPECIFICATIONS

Imager Size	Model	Focal Length (mm)	Aperture Range (c=close)	Angular of View (HxV)	Operation			Minimum Object Distance (m)	Filter Size (mm)	Max. Diameter (mm)	Overall Length (mm)	Weight (g)	Mount
					Iris	Focus	Zoom						

## MEGAPIXEL HIGH RESOLUTION

2/3	23FM16SP	16	1.4~C	30.9°x23.4°	Manual w/lock	Manual w/lock	—	0.15	30.5	∅34	38	80	C
	23FM25SP	25	1.4~16	20.0°x15.1°	Manual w/lock	Manual w/lock	—	0.15	30.5	∅34	52.2	103	C
	23FM50SP	50	2.8~16	10.1°x7.6°	Manual w/lock	Manual w/lock	—	0.20	30.5	∅34	77.5	117	C

## STANDARD HIGH RESOLUTION

2/3	23FM65	6.5	1.8~C	71.6°x55.5°	Manual w/lock	—	—	0.15	—	∅37	31.5	60	C
	23FM08	8	1.4~16	59.3°x45.8°	Manual w/lock	Manual w/lock	—	0.26	25.5	∅29	27	40	C
	23FM08L	8	1.4~16	59.3°x45.2°	Manual w/lock	Manual w/lock	—	0.26	25.5	∅30.5	27	48	C
	23FM12	12	1.8~16	40.9°x30.9°	Manual w/lock	Manual w/lock	—	0.26	25.5	∅29	27	40	C
	23FM12L	12	1.8~16	40.9°x30.9°	Manual w/lock	Manual w/lock	—	0.26	25.5	∅30.5	27	46	C
	23FM16	16	1.4~16	30.9°x23.2°	Manual w/lock	Manual w/lock	—	0.29	25.5	∅29	25	50	C
	23FM16L	16	1.4~16	30.9°x23.2°	Manual w/lock	Manual w/lock	—	0.29	25.5	∅30.5	25	48	C
	23FM25	25	1.6~16	20.0°x15.0°	Manual w/lock	Manual w/lock	—	0.25	25.5	∅29	25.5	37	C
	23FM25L	25	1.6~16	20.0°x15.0°	Manual w/lock	Manual w/lock	—	0.25	25.5	∅30.5	25.5	40	C
	23FM35L	35	2.1~22	14.3°x10.8°	Manual w/lock	Manual w/lock	—	0.3	25.5	∅30.5	32	44	C
	23FM50	50	2.8~22	10.0°x7.5°	Manual w/lock	Manual w/lock	—	0.44	25.5	∅29	38.5	50	C
	23FM50L	50	2.8~22	10.0°x7.5°	Manual w/lock	Manual w/lock	—	0.44	25.5	∅30.5	38.5	52	C
	23FM75	75	3.9~32	6.9°x5.2°	Manual w/lock	Manual w/lock	—	0.5	25.5	∅27.5	65.5	64	C
	23FM75L	75	3.9~32	6.9°x5.2°	Manual w/lock	Manual w/lock	—	0.5	25.5	∅27.5	65.5	68	C

## SUPER HIGH RESOLUTION

2/3	26HA	25	1.4~C	19.9°x15.0°	Manual w/lock	Manual w/lock	—	0.6	40.5	∅45.3	41	145	C
-----	------	----	-------	-------------	---------------	---------------	---	-----	------	-------	----	-----	---

**Caution:** Please read the instruction manual carefully before using the lens.

# TAMRON®

Manufacturers of lenses for photographic, industrial, laboratory, video, and scientific applications.

**TAMRON USA, INC.**

10 Austin Boulevard  
Commack, NY 11725  
(631) 858-8400  
Fax (631) 543-5666  
www.tamron.com



**ISO 9001 Certified**

Tamron operates a quality management system that has been certified as conforming to ISO9001.

**ISO 14001 Certified**

Tamron operates an environmental management system that has been certified as conforming to ISO14001.